

Synergy 21 in ground ARGOS round mini IP67 ww V2

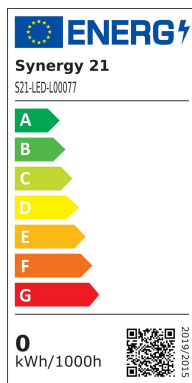

kwh/1000h: 0,50

Lumens: 80

Watt: 0,3

Nominal Service Life: 35000 Std.

Switching Cycles: 15000

Opt. Ambient Temperature.: 25 °C

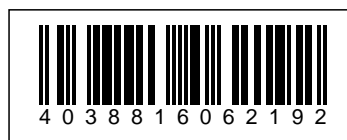

Voltage: DC 12V
Power: 0,3W
LED light colour: ww, 3000K ±150
LED: 1 piece SMD2835
Cover: tempered glass, loadable up to 100kg
Material: 304/316 stainless steel
Protection class: IP67
Size: Ø 30mm, height 18.5mm
Installation dimension: Ø 24mm
Weight: 20g
Connection cable: AWG22 (2-pole) with IP67 plug

Attributes

Attribute	Value
Ampere:	0.02
CC oder CV:	CV
Dimmbar:	abhängig vom Netzteil
Grösse:	30*18,5
LED - Gehäusefarbe:	Silber

Attribute	Value
LED - Gehäusematerial:	Edelstahl
Lichtfarbe:	warmweiß
Schutzklasse:	IP67
Volt:	12
Weight:	0.04 Kg
Warranty:	24.00 Months

Additional Images

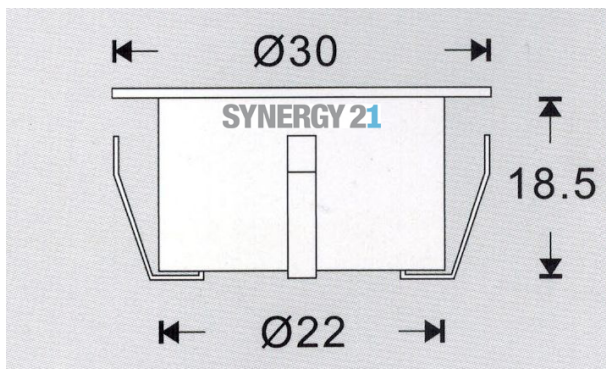

SYNERGY 21

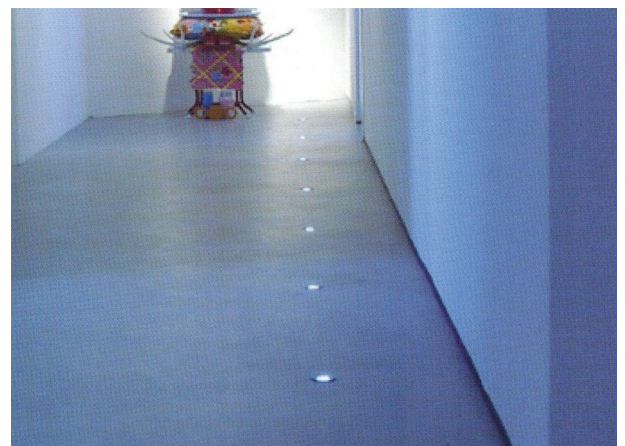
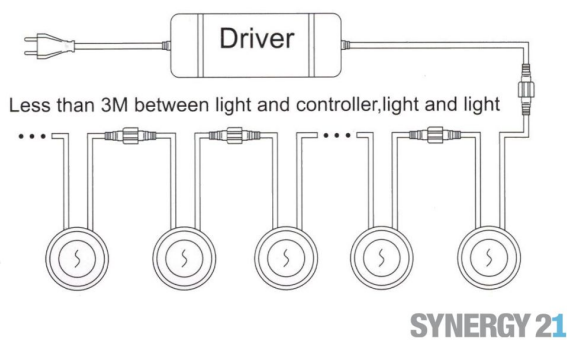
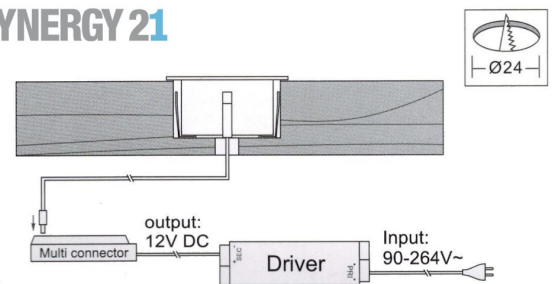

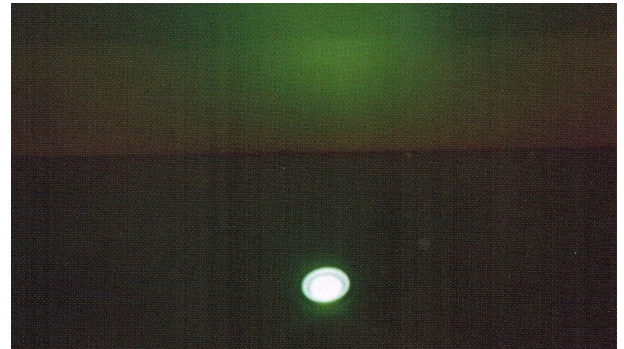

Accessories

Part No.	Name
156522	Synergy 21 LED in-ground spotlight ARGOS with solar panel inc. rechargeable battery 10W
156529	Synergy 21 ARGOS LED in-ground spotlight with solar panel
109456	Synergy 21 LED recessed floor floodlight ARGOS with power supply 12V / 3W IP67
109457	Synergy 21 LED in ground ARGOS zub power supply 12V / 8W IP67
109458	Synergy 21 LED in ground ARGOS zub power supply 12V / 30W IP67
109461	Synergy 21 LED in ground ARGOS zub extension cable IP67 1m
109462	Synergy 21 LED in ground ARGOS zub Extension Cable IP67 2m
109463	Synergy 21 LED in ground ARGOS zub Extension Cable IP67 3m
109469	Synergy 21 LED in ground ARGOS zub Tee IP67
109473	Synergy 21 LED in ground ARGOS zub end cap IP67
113976	Synergy 21 LED recessed floor floodlight ARGOS with extension cable IP67 1m
178007	Synergy 21 LED recessed floor spotlight ARGOS with single color dimmer IP67
109460	Synergy 21 ARGOS LED in-ground spotlight with twilight sensor IP67
109471	Synergy 21 LED recessed floor spotlight ARGOS with junction box IP67